

SAFETY

Product Guide

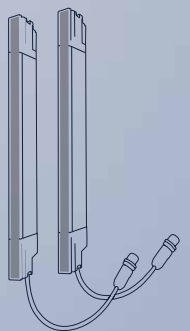
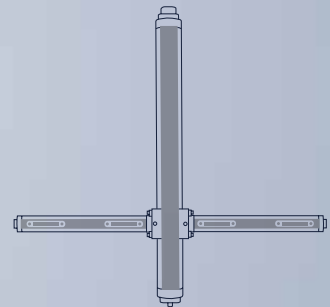
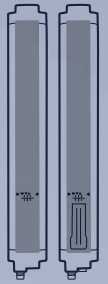
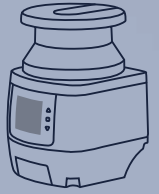

SENSORS & SAFETY

Datalogic has more than 40 years of experience in the sensors and safety sector, developing their first product, a Photoelectric Sensor, in 1972. Today, Datalogic is one of the largest manufacturers of sensor and safety products worldwide.

Datalogic is the market leader in Italy for photoelectric sensors and safety light curtains, ranking among the top-10 manufacturers in Europe by market share*

Datalogic's Sensors and Safety portfolio solves customer applications in Factory Automation, specializing in Processing and Packaging machinery, and Automated Material Handling Systems related to Manufacturing Industries such as Automotive, Electronics, Pharmaceutical, Food & Beverage, Paper and Printing, Wood-working, Ceramics, Glass, Textiles etc.

Datalogic is also improving and renewing its wide sensor portfolio with new product families and accessories, specifically developed for **IO-Link** connectivity offering a wide solution range for any **INDUSTRY 4.0** application.

**(source: based on VDC 2010 - 2011)*

Tubular, Miniature and Fiber Optic sensors for object detection

Inductive proximity sensors

Fork sensors for label detection

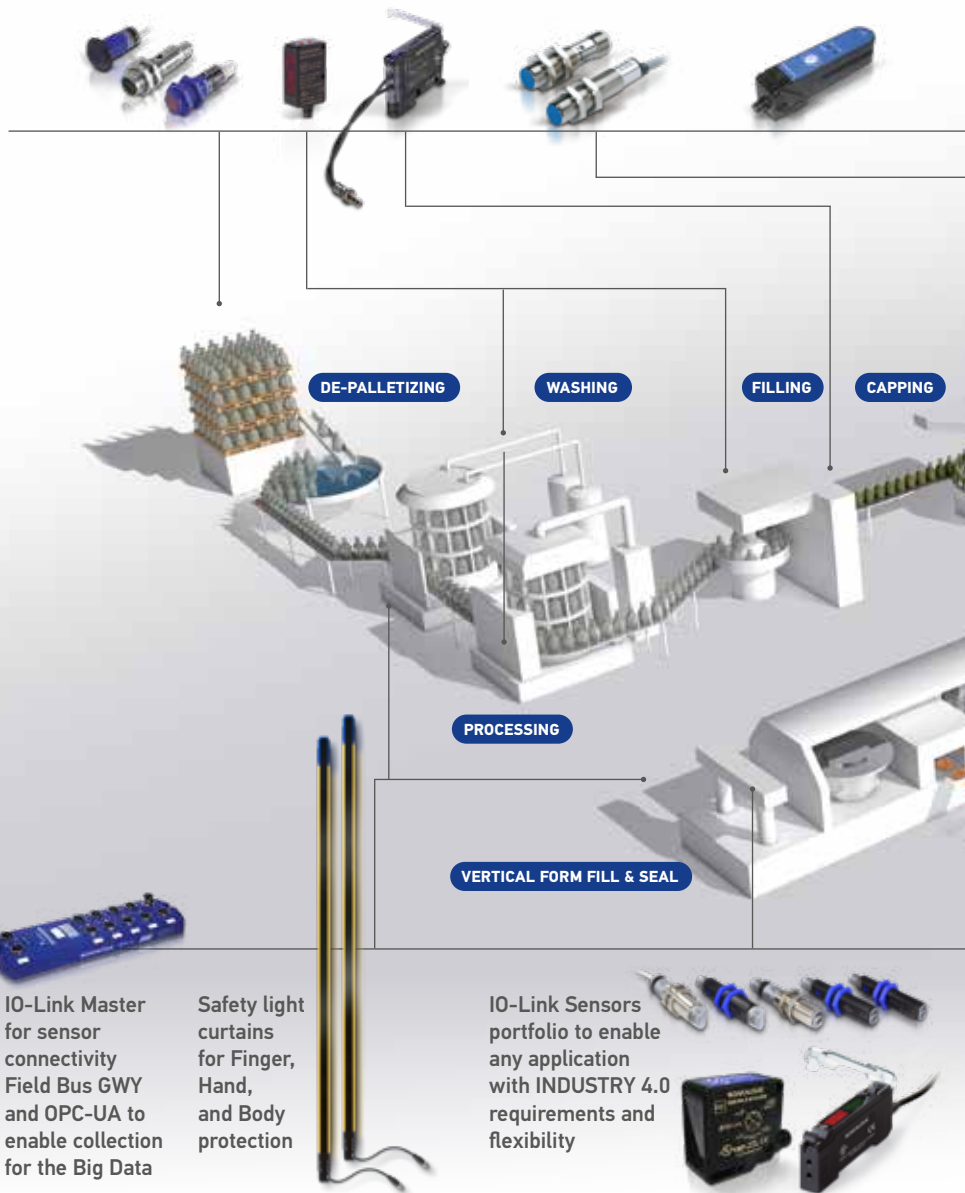

APPLICATIONS

- De-Palletizing
- Storage & Retrieval
- Washing
- Cartoning
- Filling
- Wrapping
- Capping
- Vertical Form Fill & Seal
- Labeling
- Processing
- Case Packing
- Stretch-wrapping
- Palletizing



IO-Link Master for sensor connectivity Field Bus GWY and OPC-UA to enable collection for the Big Data

Safety light curtains for Finger, Hand, and Body protection



IO-Link Sensors portfolio to enable any application with INDUSTRY 4.0 requirements and flexibility



SENSOR PRODUCTS

SENSORS PRODUCT RANGE

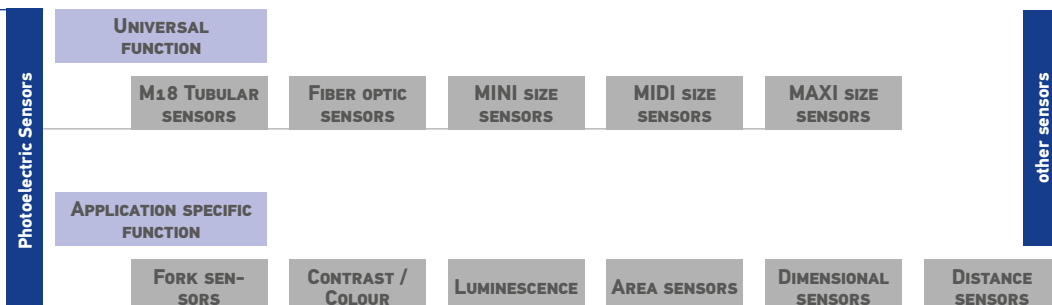

Inductive
Ultrasonic
Capacitive
Temperature

Contrast and Luminescence sensors



Area sensors



Maxi and Compact sensors for object detection



Safety laser scanner for area protection

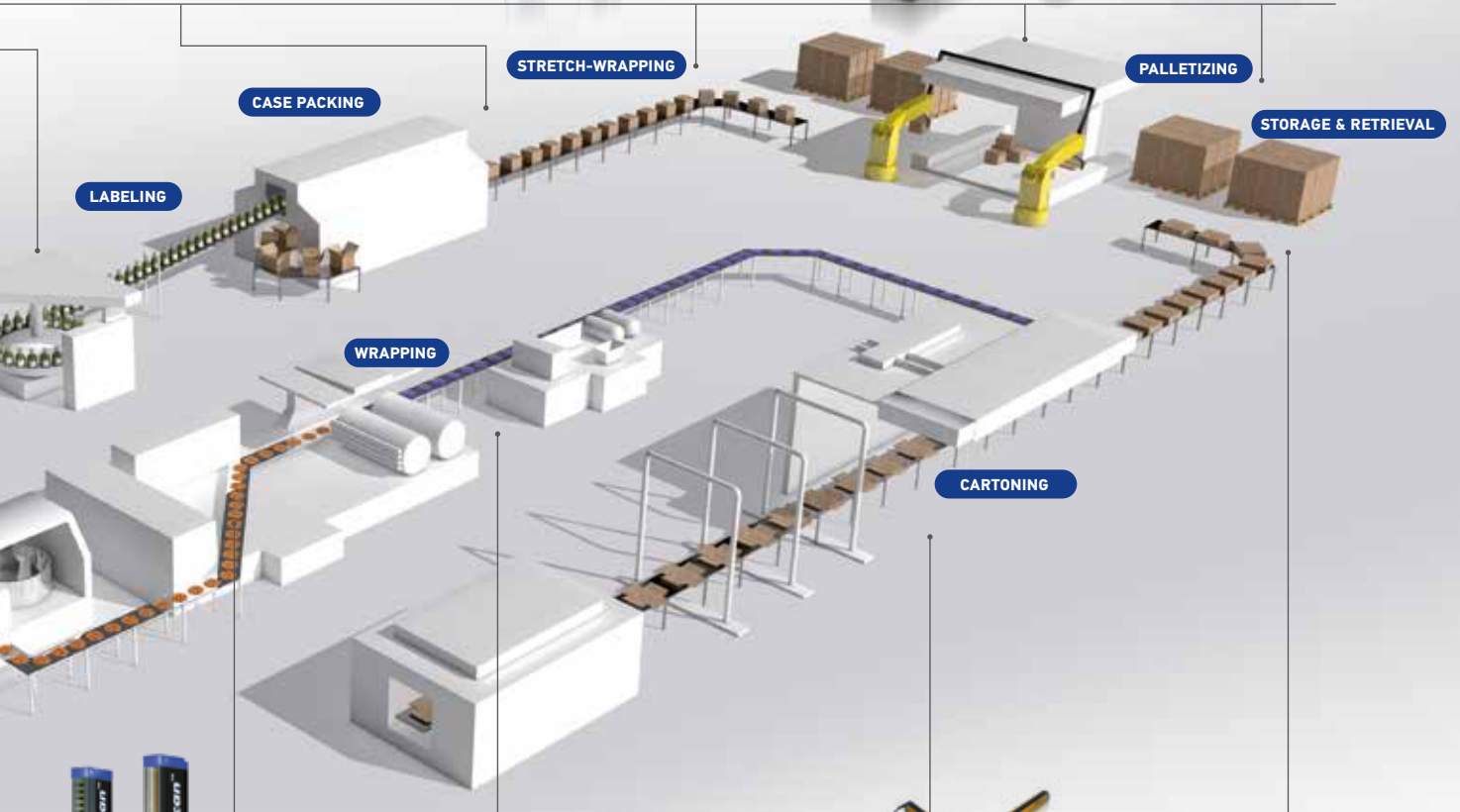

Dimensional sensors for height/width measurement and object positioning



TOF distance sensors for measurement and object positioning



Safety light curtains for body protection with Muting function

SAFETY PRODUCTS

SAFETY PRODUCT RANGE

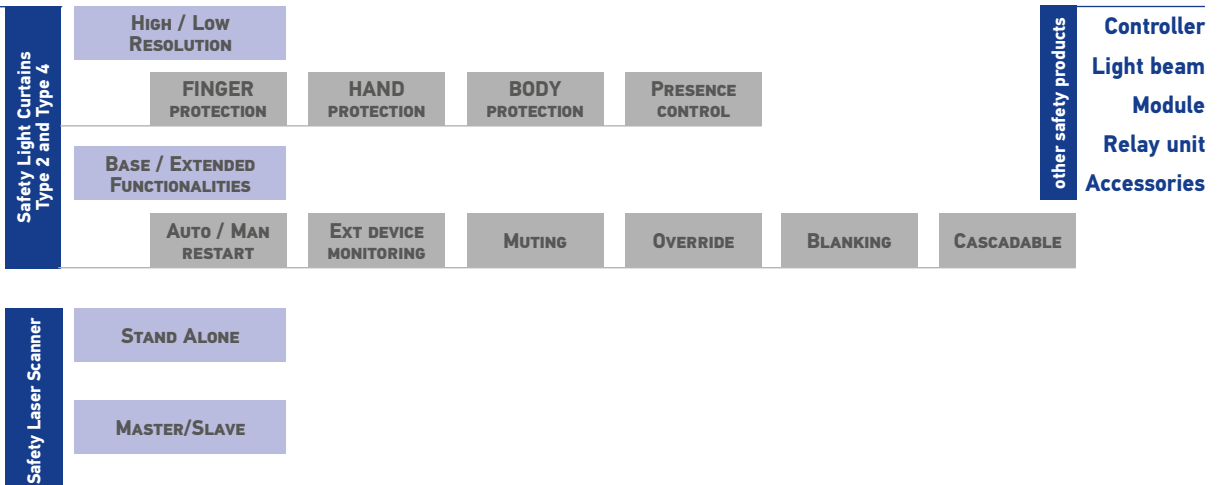

SAFETY PRODUCTS

Safety Laser Scanner

LASER SENTINEL ENHANCED

LASER SENTINEL is the innovative solution for safe area protection in a large variety of applications in automation and intralogistic industries. It offers a complete and flexible solution for the safeguard of robotic cells, automated guided vehicles and general machinery.

Technical data

- Type 3 / PL d / SIL 2
- Maximum distance: up to 5.5 m (safe) for 70 mm resolution
- Opening angle: 275°
- Minimum response time: 62 ms
- *STANDALONE* version: - pigtail with M12 connector - up to 6 switchable zone sets
- *MASTER-SLAVE* version: - M12 connector - rotating connectors for programming and connection to slaves- safe communication between up to 4 scanners -up to 70 switchable zone sets
- Programming, monitoring and measurement data: Ethernet
- Dimensions (w,d,h): 102 , 112.5 , 152 mm
- Auto/manual restart, EDM, partial dynamic muting, override, speed measurement, *shut off*
- Fast replacement

Applications

- Robot cells
- Automated Guided Vehicles
- Automatic machinery
- Material handling



Safety Light Curtains

SG4 FIELDBUS

SG4 FIELDBUS is the first safety light curtain with integrated openSAFETY protocol over POWERLINK network.

With finger, hand and body protection, SG4 FIELDBUS can be used in any application where standard SG4 safety light curtains are currently used.

Technical data

- openSAFETY protocol over POWERLINK
- Type 4 / PL e / SIL 3
- Resolution: 14/30 mm or 2/3/4 beams
- Protected height: 150 ... 1800 mm
- Operating distance: up to 20 m
- Operating temperature: 0 ...+55 °C
- Mechanical protection: IP65

Applications

- Metal working
- Primary and secondary packaging
- Machine tools
- Warehouses
- Automotive



Safety Light Curtains

SG2/SG4 BASE

Finger and hand presence safety detection with basic functions
High reliability, easy installation and alignment, cost effective solution for simple protection needs.

Technical data

- Safety Type 2 (Pl=c, SIL1); Safety Type 4 (Pl=e, SIL3)
- Resolution Finger 14mm; Hand 30mm; Pres. 50/90mm
- Controlled heights from 150 to 1800mm (n x 150mm)
- Operating distance: Finger 6m; Hand 19m; Pres. 9/19m
- Auto/Manual restart; EDM; Anti-interference coding
- Easy and cost effective standard M12 5-pole connector

Applications

- Automatic machinery
- Metalworking, Woodworking
- Manufacturing (textile, ceramics, etc)
- Material handling, assembly lines



Safety Light Curtains

SG4 EXTENDED

Finger and hand safety detection with possibility of configuration of advanced functions through pushbuttons or Graphic User Interface.
Extended flexibility that fits a diverse range of machine needs, combined with possibility of Ethernet connection for remote monitoring.

Technical data

- Programmable Safety Light Curtain Type 4 (Pl=e, SIL3)
- Resolution: Finger 14 mm; Hand 30 mm
- Controlled heights from 300 to 1800mm (n x 150mm)
- Operating distance: Finger 7m; Hand 20m
- Compact; No dead zone; up to 3 cascable units
- Fully programmable: Auto/Man restart, EDM, coding, Muting (T/L, total/partial, with/without timeout, etc.), Fixed/floating blanking; reduced resolution function
- Ethernet Port, SG Dongle and Graphic User Interface

Applications

- Processing and packaging machines
- Automotive, metalworking, presses
- Manufacturing assembly lines



Safety Light Curtains

SLIM

Ultra-compact safety light curtain with finger and hand resolution for applications where space saving and mechanical flexibility is a must.

Technical data

- Safety Type 2 (Pl=c, SIL1); Safety Type 4 (Pl=e, SIL3)
- Resolution: 14/24/34 mm
- Protected height: 150, 210, 270 ... 1200 mm
- (with 30 mm steps)
- Operating distance: 0.2 ... 6m
- Outputs: 2 PNP; Output current: 0.3 A max / each output
- Mechanical protection: IP65
- Restart: Manual/Automatic
- Other functions: External Device Monitoring (EDM)

Applications

- Robot cells
- Automated Guided Vehicles
- Automatic machinery
- Material handling



Safety Light Curtains

SG4-H

Finger protection in applications where high hygienic requirements need frequent cleanings with highly corrosive detergents. The first safety light curtain with stainless steel housing and glass.

Technical data

- Safety Type 4 (Pl=e, SIL3);
- Resolution: 14 mm
- Protected height: 150/300/450 mm
- Operating distance: 0.2 ... 6m
- Outputs: 2 PNP; Output current: 0.5 A max/each output
- Mechanical protection: IP69K
- Restart: Automatic

Applications

- Liquid filling machines
- Powder filling machines
- Closing and cap sealing machines



Safety Light Curtains

SG BODY COMPACT

Body safety protection and perimeter access control
High reliability, easy installation and alignment, cost effectiveness.

Technical data

- 35x40 mm standard compact profile
- 2, 3 or 4 beams for Body protection and access control
- Controlled heights of 500, 800, 900, 1200 mm
- Long operating distance up to 50 m
- Dip-switch configuration of Auto/Man, EDM, Coding
- Muting version with L or T integrated arms and lamp
- Easy and cost effective standard M12 connectors

Applications

- Palletizers/depalletizers
- Conveyor lines
- Automated warehousing
- Manufacturing lines



Safety Light Curtains

SG BODY BIG

Body safety protection and perimeter access control
Robust product with high reliability and easy installation.

Technical data

- 52x56mm profile with improved mechanical resistance
- 2, 3 or 4 beams for Body protection and access control
- Controlled heights of 500, 800, 900, 1200mm
- Longer operating distance of 60m
- Dip-switch configuration of Auto/Man, EDM, Coding
- Muting version with integrated arms and top-lamp
- Reflector version with active unit and passive unit

Applications

- Palletizers/depalletizers
- Automotive, robotized lines
- Automated storage and retrieval
- Automated warehousing
- AGV and forklift area protection





Datalogic-Produkte erhalten Sie bei



SCHWALENBERG
Betriebs- und Datentechnik GmbH

Ilseder Hütte 10, 31241 Ilsede
Tel.: 05172 1290-0, Fax: 05172 1290-12
E-Mail: info@schwaleberg.com
Internet: www.schwaleberg.com

The Schwaleberg logo consists of a colorful arc with a blue circle at its peak, positioned above a blue rectangular box containing the word "SCHWALENBERG" in white, bold, sans-serif capital letters. Below this box, the text "Betriebs- und Datentechnik GmbH" is written in a smaller, black, sans-serif font.

Rev. 04, 12/2019



9C514900E